A DIE SETS



B PRECISION GROUND PLATES AND FLAT BARS



C LIFTING AND CLAMPING DEVICES



D GUIDE ELEMENTS



E GROUND PRECISION COMPONENTS



F SPRINGS



G ELASTOMERS



H FIBRO-CHEMICAL TOOLING AIDS



Casting resins, metal adhesives, oils and greases



J PERIPHERAL EQUIPMENT



K CAM UNITS



L STANDARD PARTS FOR MOULD MAKING



FIBRO-CHEMICAL TOOLING AIDS



FIBRO-CHEMICAL TOOLING AIDS

GENERAL INFORMATION

Safety data sheets

The safety data sheets obligatory for the chemical products can be found on our website (www.fibro.de) for the Standard Parts division under Downloads .

Information on availability in your country/region



The legal requirements for chemical products have become significantly more stringent in recent years. As part of the European Union, the same conditions have been established with the CLP/REACH ordinance. Nevertheless, there are additional country-specific regulations or laws that are to be observed for delivery to EU countries.

Outside the EU, it is still considerably more complex, even though a number of countries are basing their regulations on CLP/REACH. FIBRO as a manufacturer and reseller is obligated to meet all laws and regulations.





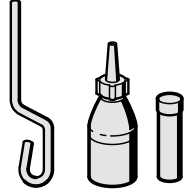

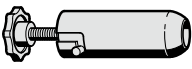
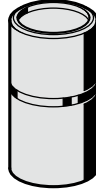
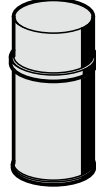
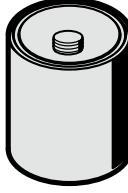
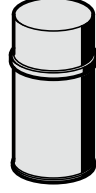
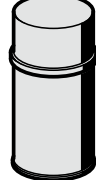

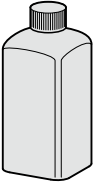

Therefore, please note that the products may not be available in your country!

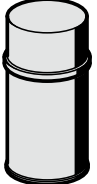
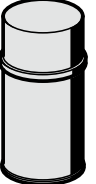
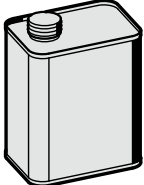
Please also note that chemical products can only be used in countries where the language on the labels corresponds to the official language as appropriate.

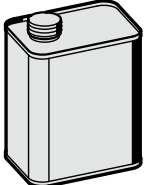
CONTENTS

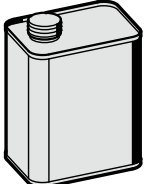
		H7			H12
	Application of the products - Selection matrix			Tooling resin FIBROLIT®-ZWO / FIBROFIX®-SECHS - Properties	
		H8			H12
	Tooling resin - Description			Thinning agent for FIBROLIT®-ZWO - Properties	
	280.02 Tooling resin FIBROLIT®-ZWO	H8		FIBROLIT®-MK Metal Adhesive - Properties	H12
	280.08 Tooling resin FIBROFIX®-SECHS	H8			
	280.05 Hardener	H9			
	280.24 Thinning agent for FIBROLIT® ZWO	H9			
	280.09 Injection gun for FIBROFIX®-SECHS	H9			
		H10-11			
	Tooling resin FIBROLIT®-ZWO / FIBROFIX®-SECHS - Example applications				
				281.01 Metal adhesive FIBROLIT® MK	H13
				280.822405 Release agent ACMOS	H13
				280.27 Release agent FIBROLIT® TW	H13
				280.15 Rust/corrosion releasing lubricant/ Agent FIBROLIT®-RL	H14
				280.131 Marking out blue FIBROLIT®-ARF	H14

CONTENTS

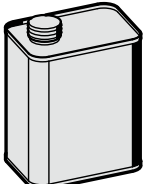
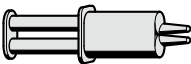
	280.23 Marking out blue FIBROLIT®-ARF	H14		281.706 Quick cleaner LOCTITE® SF 7061	H18
	280.20 Leak detector spray FIBROLIT®-LSP	H15		281.30 DEGREASER EM30+	H18
	280.37.032. Hydraulic oil FIBROLIT®	H15		280.8001 Oil LOCTITE® LB 8001	H19
	281.620. Cooling liquid FIBROLIT®	H15		280.8021 Silicon oil LOCTITE® LB 8021	H19
	280.36.006 Stamping lubricating oil FIBROLIT®	H16		281.243 Threadlocker, medium-strength LOCTITE® 243	H20
	H17 FIBROLIT® FETT/OEL-LD - Description			281.270 Threadlocker, high-strength LOCTITE® 2701	H20
	280.34 Grease FIBROLIT®Fett-LD	H17		281.648 Retaining compound, high-strength LOCTITE® 648	H20
	280.35 Lubricating oil FIBROLIT®Oel-LD	H17		281.147 Epoxy adhesive LOCTITE® EA 3450	H21

CONTENTS



281.401

H21

Instant adhesive LOCTITE® 401

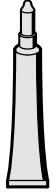

281.454

H21

Instant adhesive gel LOCTITE® 454

APPLICATION OF THE PRODUCTS - SELECTION MATRIX

Product	Term	Casting	Joining	Securing	Bonding	Purifying/degreasing	Deburring	Separation	Lubrication	Protection	Scribing	Other
280.02	Tooling resin FIBROLIT®-ZWO	●										
280.05	Hardener	●										
280.08	Tooling resin FIBROFIX®-SECHS	●										
280.15	Rust/corrosion releasing lubricant/Agent FIBROLIT®-RL					●	●			●		
280.20	Leak detector spray FIBROLIT®-LSP											●
280.23	Marking out blue FIBROLIT®-ARF										●	
280.24	Thinning agent for FIBROLIT® ZWO	●										
280.27	Release agent FIBROLIT® TW							●				
280.34	Grease FIBROLIT®Fett-LD								●			
280.35	Lubricating oil FIBROLIT®Oel-LD								●			
280.36.006	Stamping lubricating oil FIBROLIT®								●			
280.37.032.	Hydraulic oil FIBROLIT®											●
280.131	Marking out blue FIBROLIT®-ARF										●	
280.8001	Oil LOCTITE® LB 8001								●			
280.8021	Silicon oil LOCTITE® LB 8021							●	●			
280.822405	Release agent ACMOS							●				
281.01	Metal adhesive FIBROLIT® MK		●									
281.30	DEGREASER EM30+					●						
281.147	Epoxy adhesive LOCTITE® EA 3450		●		●							
281.243	Threadlocker, medium-strength LOCTITE® 243			●								
281.270	Threadlocker, high-strength LOCTITE® 2701			●								
281.401	Instant adhesive LOCTITE® 401				●							
281.454	Instant adhesive gel LOCTITE® 454				●							
281.620.	Cooling liquid FIBROLIT®											●
281.648	Retaining compound, high-strength LOCTITE® 648		●									
281.706	Quick cleaner LOCTITE® SF 7061					●						

TOOLING RESIN - DESCRIPTION

TOOLING RESIN FIBROLIT®-ZWO

TOOLING RESIN FIBROFIX®-SECHS

Description:

The two tool casting resin products 280.02 FIBROLIT®-ZWO and 280.08 FIBROFIX®-SECHS are used in very different applications and each consist of the two components casting resin and hardener.

Casting resin and hardener are mixed in a certain ratio and react irreversibly to form a solid (thermoset) through a chemical cross-linking reaction. The cross-linking reaction is started by mixing the casting resin and hardener. During what is known as the pot life, the casting resin is liquid and processable. It must then be processed mechanically.

For the typical use in tool-making, the casting resin contains optimised fillers. The hardener contains accelerators and additives that ensure a curing time that is not excessively long.

For surfaces on which the tool casting resin should not adhere, the use of 280.822405 release agent or 280.27 release agent FIBROLIT®-TW is recommended.

Casting resin and hardener are substances which are hazardous to health and the environment when not cured. Special protective measures according to the safety data sheets must therefore be observed.



280.02 Tooling resin FIBROLIT®-ZWO

Description:

The tool casting resin FIBROLIT®-ZWO is an epoxy resin for use in tool construction and other applications. The can size is dimensioned so that thorough stirring and mixing can be carried out in the can. The two components are optimally matched with regard to the quantity ratio to guarantee complete curing of the casting resin. The casting resin must be thoroughly stirred before and after adding the hardener. This is the only way to ensure perfect curing.

If smaller quantities are to be removed, a mixing ratio of casting resin/hardener of 18:1 (parts by weight) must be observed.

Note:

Follow the instructions for use!

Physical characteristics, chemical resistance and application examples on the following pages.

Despatch packaging contains:

- 1 can of casting resin, 365 ml
- 1 bottle of hardener, 50 ml



280.08 Tooling resin FIBROFIX®-SECHS

Description:

Casting resin units for fast and clean processing of small quantities of casting resin. FIBROFIX®-SECHS has the same properties as FIBROLIT®-ZWO, so the same processing instructions apply. The application is preferably carried out with an injection gun 280.09.

Note:

Follow the instructions for use!

Physical characteristics, chemical resistance and application examples on the following pages.

Despatch packaging contains:

- 6 cartridges of casting resin, 33 ml
- 6 hardener ampoules, 4 ml
- 1 stirring rod

HARDENER

THINNING AGENT FOR FIBROLIT® ZWO

INJECTION GUN FOR FIBROFIX®-SECHS

280.05 Hardener

Description:

Individual hardener for 280.02 FIBROLIT®-ZWO tool casting resin or for use with epoxy resin 280.24 thinning agent for FIBROLIT®-ZWO.

Bottle, 50ml



280.24 Thinning agent for FIBROLIT® ZWO

Description:

To increase the flow properties of FIBROLIT® ZWO tool casting resin, the thinner (pure epoxy resin) can be added in a specific ratio (max. 5% = 45 g).

It must be noted that the addition of thinner will extend the curing time.

The thinner can also be used together with hardener 280.05 as a casting resin. A resin/hardener mixing ratio of 5:1 (by weight) must be observed.

Can, 500 ml



280.09 Injection gun for FIBROFIX®-SECHS

Description:

For simple application of FIBROFIX®-SECHS 280.08.

The casting resin cartridge is compressed by means of a threaded spindle and removed from the injection gun after emptying.



TOOLING RESIN FIBROLIT®-ZWO / FIBROFIX®-SECHS - EXAMPLE APPLICATIONS

Casting of punch guides in guiding strippers (with sliding movement)

Suitable apertures in the stripper can be marked out from finished matrix. Allowance must be made for a casting gap of 1 - 3 mm around the punch.

Prolonged storage and cold can cause the resin to become stiff and unworkable. Place resin container in hot water of about 60 °C, then stir thoroughly and let cool down to room temperature.

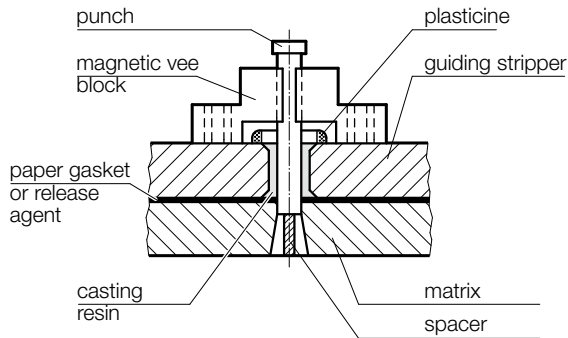

Fig. 1:
Casting of punch guide in guiding stripper

Quite often it will suffice to drill a hole in approximation of a shaped aperture – as shown in fig. 2.

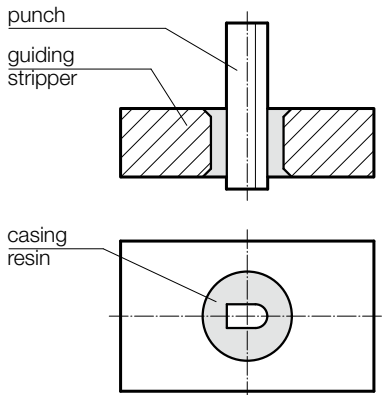

Fig. 2:
Cast guide for form punch

For casting of very narrow gaps there is also the option to use FIBROLIT® thinner.

The sawn or drilled contours must be degreased. As shown in figure 1, the prepared guide plate is clamped with the cutting plate and the punch, the punch coated with a release agent is inserted into the opening and aligned. Before casting, it is advisable to limit the overflowing casting resin mass with a plasticine edge. It also serves as a casting aid. Paper or release agent is applied between the cutting and guide plates to prevent mutual sticking. The vertical position of the punches is achieved via a magnetic angle. There are various methods for maintaining the kerf in the cutting plate.

A common method for alignment between the punch and the hole in the hardened cutting plate, which is also preferable for repairs, is the interposition of metal foils or nylon fabrics according to the desired kerf. In the case of split cutting plates ground to shape, it is also customary to pre-grind the apertures first cylindrically without kerf. Only after casting the guide plate are the kerf and regrinding implemented on the cutting plate inserts.

With simple dies, the following execution leads to expedient and good results:

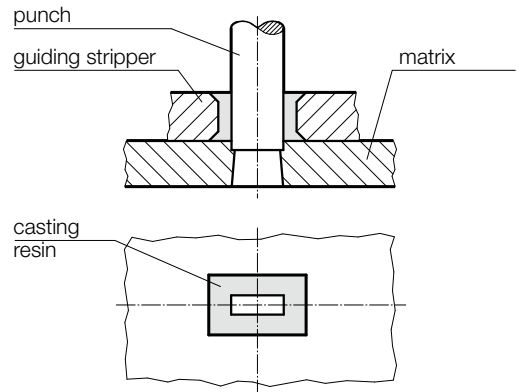

Fig. 3:
Casting of punch guide with basic blanking tools

The punch is aligned in terms of dimensions and angles. After pressing the punch into the cutting plate, the guide rails are removed and the cutting plate is pinned to the guide plate prepared for casting. This is followed by casting and finishing the cutting plate breakthrough.

For guide cuts, the guide plate or the wiper can be provided with additional plates on the underside, figure 4. These plates prevent premature wear of the punch guide plate. The oil pan for fast-running tools is also produced during the pouring process.

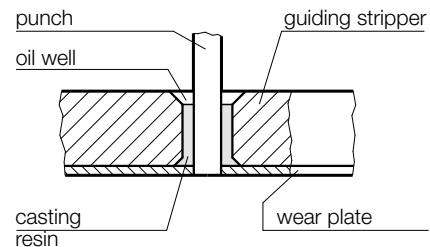

Fig. 4:
Cast punch guide with oil well and wear plate underneath stripper

Quill punches ought to be given maximum support over their length; a typical cast stripper guide for such thin punches is shown in fig. 5.

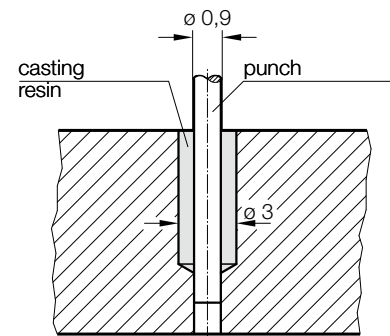

Fig. 5:
Cast guide for thin Quill-Type Punch

TOOLING RESIN FIBROLIT®-ZWO / FIBROFIX®-SECHS - EXAMPLE APPLICATIONS

Figure 6 shows a punch guide plate with dowel pins (235.1). The holes for the dowel pins are drilled on the jig boring machine and the hole is sawn out. After the hardened dowel pins have been pressed in, the punch is cast. The punch guide is more wear-resistant due to the line contact between the punch and the cylindrical pins and alignment is not necessary.

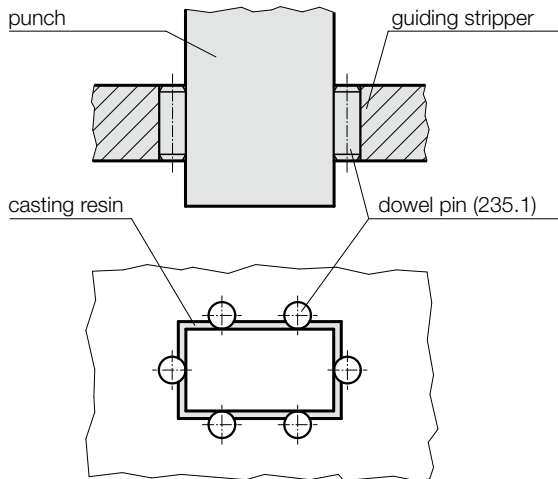

Fig. 6:
Cast punch guide with jig-bored positioning dowel pins

A punch guide plate with a large number of forming punches is shown in figure 7. All holes are drilled or sawn and then cast.

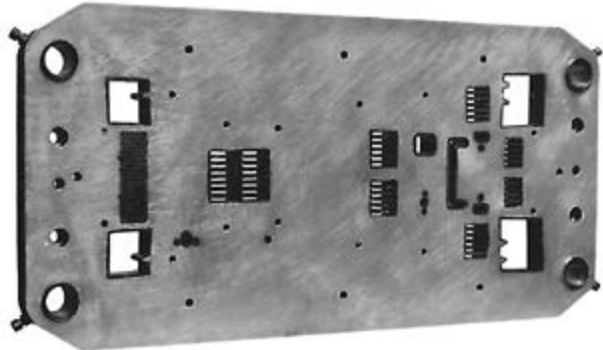
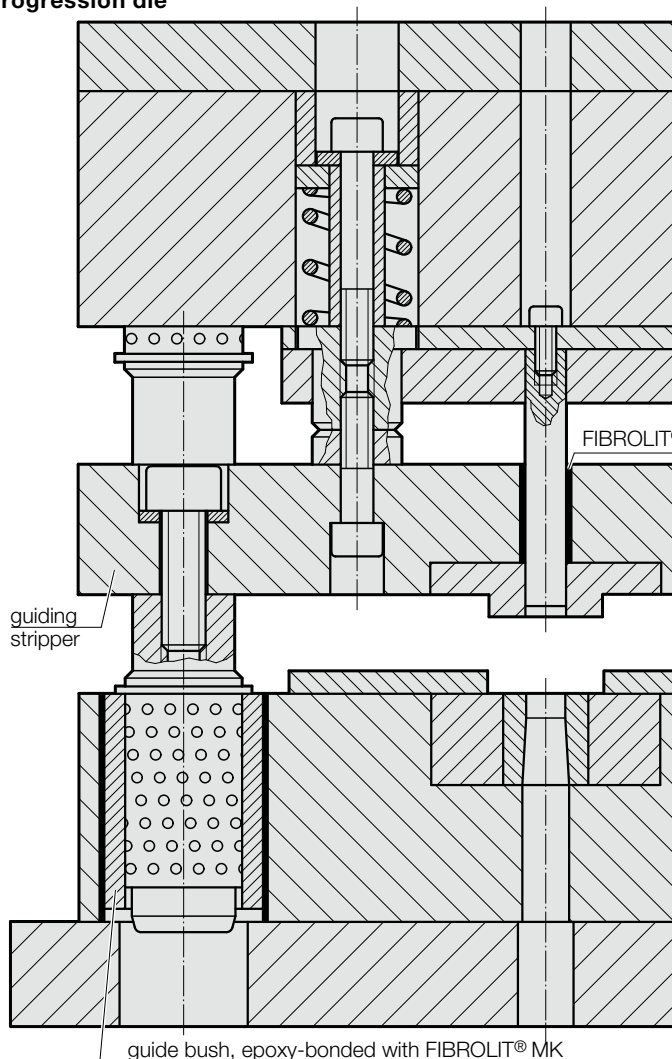

Fig. 7
Cast punch guide plate

We would like to be able to calculate for you how much time (time = money!) has been saved with this tool alone. This is not really possible using a photo, though. As an expert, you are certain to be able to see the potential savings here for yourself.

Examples of epoxy-casting and epoxy-bonding work in a progression die



Cast cylinder pin bushes:

These hardened liner bushes are used to great advantage where it is necessary to dismantle or replace unhardened components frequently – for instance in precision stamping dies etc. The jig-ground dowel pin holes in the hardened and ground plates assure perfectly accurate interchangeability. The unhardened counterpart is brought into precise position and alignment by way of casting-in of the hardened liner bushes. Either FIBROLIT® ZWO or FIBROFIX® SECHS is used for casting.

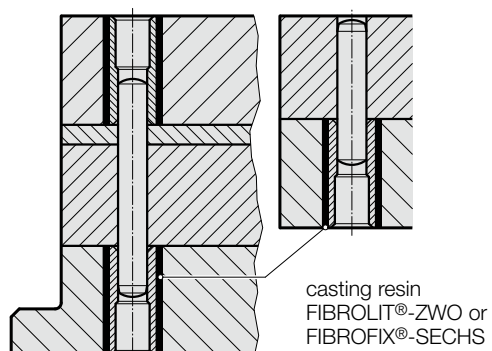

TOOLING RESIN FIBROLIT®-ZWO / FIBROFIX®-SECHS - PROPERTIES

THINNING AGENT FOR FIBROLIT®-ZWO - PROPERTIES

FIBROLIT®-MK METAL ADHESIVE - PROPERTIES

Physical properties tooling resin FIBROLIT®-ZWO / FIBROFIX®-SECHS:

viscosity at 25 °C	approx. 9000 mPas
pot life at 25 °C (mixed = 100 g)	approx. 25 min.
curing time at 20 - 25 °C*	approx. 24 h
shelf life at 20 - 25 °C	approx. 1 year
thermal resistance (Martens) DIN 53458	approx. 50 - 55 °C (75 - 80 °C*)
flashpoint of resin	approx. 210 °C
flashpoint of hardener	approx. 207 °C
decomposition temperature (ISO/R 871-68)	>300 °C
Thermal conductivity, within range of 14-38 °C (VDE 0304 section 1/7.59)	0,531 W/km
density (resin)	approx. 2,5 g/ml
density (hardener)	approx. 1.06 g/ml
compressive strength DIN EN ISO 604	approx. 130 - 140 N/mm ²
tensile strength DIN EN ISO 527-1, -2, -3	approx. 50 N/mm ²
flexural strength DIN EN ISO 178	approx. 70 N/mm ²
ball indentation test DIN EN ISO 2039-1	approx. 213 N/mm ²
impact test	3,57 KJ/m ²
modulus of elasticity (ex tensile test)	approx. 8760 N/mm ²
linear shrinkage	approx. 0.05 - 0.12 %

*Cured at ambient room temperature for 24 hours, or 15 hours at 50 °C

Physical properties thinning agent for FIBROLIT®-ZWO:

Density	1,16 ± 0,02 g/ml
flash point (DIN 51584)	97 °C
shelf life at 20 - 25 °C	approx. 1 year
viscosity at 25 °C	1000 ± 100 mPas

Physical properties metal adhesive FIBROLIT®-MK:

density of Resin MK	1,16 ± 0,01 g/ml
density of Hardener MK	1,13 ± 0,01 g/ml
tensile shear strength	40 - 50 N/mm ²
thermal resistance (Martens)	45 - 50 °C
pot life (100 g-mixture)	15 - 20 min
shelf life at 20 - 25 °C	approx. 1 year
time for complete curing at 20 - 25 °C	approx. 24 h

Chemical resistance

Chemical substance	Assessment
Acetone	C
Formaline 30%	B
Xylol	A
Silicone solution DC 20	A
Diesel	A
White spirits	C
Tetrachloroethylene	A
Perchloroethylene	A
Ethyl acetate	C
Epichlorohydrine	C
Fluoric acid 10%	C
Chlophen T 64	A
Water	B
Sea Water	B
NaCl solution of 5%	A
Formic acid	C
Lactic acid 10%	C
Sulphuric acid	C
Acetic acid 10%	C
Ammonia 25%	B
Aniline	C
Phenol-90	C
Hydrochloric acid 10%	B

A = no effect

B = minimal effect

C = destructive effect

METAL ADHESIVE FIBROLIT® MK

RELEASE AGENT ACMOS

RELEASE AGENT FIBROLIT® TW

281.01 Metal adhesive FIBROLIT® MK

Description:

Two-component adhesive based on epoxy resin. Mixing ratio of the resin and hardener is 2:1 by weight.

The adhesive should ideally be applied with a brush to the degreased parts to be joined. Rough surfaces improve adhesion of the metal adhesive.

After only 6.5 h, the adhesive reaches a tensile shear strength of 30 N/mm². The final strength is achieved after approx. 24 h.

The metal adhesive is suitable for an adhesion gap of 0.6 - 0.7 mm.

Adhered bushings retain their geometric roundness and accuracy to gauge via adhesion.

Despatch packaging contains:

1 can of resin, 217 ml

1 can of hardener, 119 ml



280.822405 Release agent ACMOS

Description:

Silicon-free release agent as a spray.

Application during casting for sliding parts such as gliding pins, punches etc. with 280.02 FIBROLIT®-ZWO epoxy casting resin or 280.08 FIBROFIX®-SECHS tool casting resin.

Spray on release agent thinly and evenly from a distance of 20 to 30 cm.

A smooth surface is achieved by rubbing with a soft cloth.

Aerosol spray can, 400 ml



280.27 Release agent FIBROLIT® TW

Description:

Wax-based release agent for further guide clearance.

Application during casting of sliding parts such as gliding pins, punches etc. with 280.02 FIBROLIT®-ZWO epoxy casting resin or 280.08 FIBROFIX®-SECHS tool casting resin.

Particularly suitable for rougher mould surfaces. Quick-drying and easily polishable.

Apply the release agent with a cloth and rub in well. Repeated application will produce increased clearance between the part and the resin.

Can, 500 ml



RUST/CORROSION RELEASING LUBRICANT/AGENT FIBROLIT®-RL MARKING OUT BLUE FIBROLIT®-ARF



280.15 Rust/corrosion releasing lubricant/Agent FIBROLIT®-RL

Description:

Seeps quickly and reliably into the smallest gaps to take effect there. Releases all kinds of metal joints seized due to rust (screws, bolts, nuts, etc.) and loosens them. This eliminates the need for mechanical treatment which would otherwise often be required, with the associated risk of damage.

Removes stubborn incrustations, resin deposits and accumulations of dirt that impair the functioning of moving parts.

Provides lasting protection against rust and corrosion and ensures excellent lubrication of all moving parts and joints treated with it.

Aerosol spray can, 300 ml



280.131 Marking out blue FIBROLIT®-ARF

Description:

Fast drying, excellent contrast (strength and tint) on all metals, dark blue marking dye. Enables exact marking and precise cutting contours.

The surfaces must be degreased before application.

Aerosol spray can, 400 ml



280.23 Marking out blue FIBROLIT®-ARF

Description:

Same properties as 280.131 FIBROLIT®-ARF blue marking dye.

Can, 500 ml

LEAK DETECTOR SPRAY FIBROLIT®-LSP

HYDRAULIC OIL FIBROLIT®

COOLING LIQUID FIBROLIT®

280.20 Leak detector spray FIBROLIT®-LSP

Description:

Reliable and fast detection of leaks in gases and compressed air. Testing of soldered, screwed and welded connections, fittings, valves, pressure vessels, flexible pipes, pipelines; in short, anything that has to be leak-proof. Use with all gases: compressed air, oxygen, nitrogen, hydrogen, town gas, natural gas, liquid gas, carbon dioxide, nitrous oxide, acetylene, propane, butane, other flammable gases, etc.

Spray the suspected leakage areas and easily visible foam bubbles will appear at the location of any leaks. The valve also permits spraying from below.

Non-flammable and non-corrosive.

Aerosol spray can, 400 ml



280.37.032. Hydraulic oil FIBROLIT®

Description:

High-quality hydraulic oil (DIN 51524 HVLP ISO VG32) based on mineral oil with corrosion and oxidation inhibitors as well as additives to reduce wear. Very good viscosity/temperature response. Preferably for the flex cam system (hydraulic cylinders and tool slides for tool, mould and machine construction) from FIBRO.

Can, 1 l (280.37.032.01)

Can, 5 l (280.37.032.05)



281.620. Cooling liquid FIBROLIT®

Description:

Water/glycol liquid (HFC).

Preferably for controllable gas springs (KF springs) from FIBRO.

Can, 5 l (281.620.05)

Can, 10 l (281.620.10)

Barrel, 50 l (281.620.50)



STAMPING LUBRICATING OIL FIBROLIT®



280.36.006 Stamping lubricating oil FIBROLIT®

Description:

Lubricating fluid that evaporates at ambient temperature without residue. No cleaning or degreasing required. This permits subsequent welding, soldering or common surface treatments (a suitability test is nevertheless obligatory). Excellent lubricating effect, resulting in low burr formation and extended service life on the active elements of stamping dies.

Note:

Application can be carried out by dipping, spraying and rolling. The layer thickness should be as small as possible. The use of wipers ahead of press ingress successfully controls lubricant layer. Drying time depends on temperature and time span. This time is shortened with air or heat drying.

Canister, 1000 ml (280.36.006)

Canister, 5000 ml (280.36.006.5)

Application:

- stamping of components from transformer sheet
- stamping of generator and transformer sheets and sheets for electrical components
- all kinds of forming operations
- aids for stamping and bending operations
- stamping and forming of car radiator parts

Particularly useful when punching metal sheets made of steel (carbon steel, stainless steel), aluminium, galvanised and painted sheets and copper alloys.

FIBROLIT® FETT/OEL-LD - DESCRIPTION

GREASE FIBROLIT®FETT-LD

LUBRICATING OIL FIBROLIT®OEL-LD

Description:

FIBROLIT®-FETT/OEL-LD is a coordinated lubrication concept for guide bushes made of sintered iron with a carbonitrided sliding surface for long-term and permanent lubrication.

Sintered guide bushes from FIBRO have a porosity content of 18-20% and are impregnated with 280.35 FIBROLIT®-OEL-LD lubricating oil under vacuum.

In addition to the constructive design, this impregnation provides the necessary lubricating film during operation due to capillary action. This is critical for the reliable function and long service life of the sintered guide bushings.

The FIBROLIT® FETT-LD plastic grease is the perfectly coordinated depot lubricant. This grease can also be inserted into the supply grooves of the sintered bushings, which in many cases increases the service life of the sintered guide bushings even further. To reduce start-up wear, the initial use of FIBROLIT® FETT-LD grease is recommended.

Other factors such as the good ageing stability, oxidation resistance and thermal stability of the two lubricants are equally essential for a long service life.

Please note that the use of other lubricants may lead to chemical instability of the oil impregnation!

280.34 Grease FIBROLIT®Fett-LD

Description:

Plastic oil reservoir in the form of a gel-type lubricant based on mineral oil. Initial and depot lubricant (long-term additional lubrication) for all guide bushes made of sintered iron with carbonitrided surface. Can be introduced into the supply grooves of the sintered guide bushings for this purpose. In particular in the case of applications with higher loads, the oil leakage in the sintered guide bush is compensated. High reliability and low maintenance usage due to controlled oil release. Application temperature range: -40 °C to +150 °C

Can, 400 ml



280.35 Lubricating oil FIBROLIT®Oel-LD

Description:

Mineral oil-based impregnating fluid for lubricating guide bushes made of sintered iron with carbonitrided sliding surface. Suitable for a wide range of applications due to the formulation and special additives. As additional or re-lubrication to compensate for oil leakage. Application temperature range: -10 °C to +100 °C

Can, 1000 ml



QUICK CLEANER LOCTITE® SF 7061 DEGREASER EM30+



281.706 Quick cleaner LOCTITE® SF 7061

Description:

CFC-free, solvent-based universal parts cleaner (acetone-based) used for purifying and cleaning surfaces. Before assembly, the product is used for the final cleaning and removal of most greases, oils, lubricating fluids, metal chips and ultra-fine particles from the adhesive surfaces. Due to its high dissolving power, it is also very well suited for other degreasing or parts cleaning tasks. It evaporates without residue.

Aerosol spray can, 400 ml



281.30 DEGREASER EM30+

Description:

Very effective degreaser and cold cleaner with short reaction time and fast and residue-free evaporation. Versatile for cold degreasing and purifying heavily soiled parts and surfaces. Listed by NSF® for use in the foodstuff and pharmaceutical industry.

Rapidly removes grease, oil, dirt, dirt deposits, graphite and coal dust residues. Removes tar, semi-dried paint, acrylate putty, glue, hotmelt, resins, polymers, liquid sealants, adhesives, waxes, bitumen, etc. Very good alternative to acetone, turpentine, benzine, white spirit, trichloroethylene, toluene and other dangerous cleaning agents.

Max. usage temperature: 30°C

Aerosol spray can, 500 ml

OIL LOCTITE® LB 8001

SILICON OIL LOCTITE® LB 8021

280.8001 Oil LOCTITE® LB 8001

Description:

Mineral oil-based, colourless, odourless, universal-use mineral oil spray that penetrates inaccessible areas of mechanisms, e.g. valve seats, hubs, chains, hinges and cutting knives in plants of the food processing industry and in sewing machines. It protects against friction and wear and achieves good lubrication at all speeds within its usage temperature range from -20 to +120 °C.

Aerosol spray can, 400 ml



280.8021 Silicon oil LOCTITE® LB 8021

Description:

Universally applicable, low-viscosity silicone oil which is used to lubricate metallic and non-metallic surfaces (e.g. guides, conveyor belts, cutting knives and plastic parts). It can also be used as a mould release agent.

After complete flash-off of the solvent, the product is suitable for use for applications with continuous temperature loads from -30 °C to +150 °C and with peak temperature loads of -50 °C to +250 °C.

Aerosol spray can, 400 ml



THREADLOCKER, MEDIUM-STRENGTH LOCTITE® 243

THREADLOCKER, HIGH-STRENGTH LOCTITE® 2701

RETAINING COMPOUND, HIGH-STRENGTH LOCTITE® 648



281.243 Threadlocker, medium-strength LOCTITE® 243

Description:

Universally applicable medium-strength threadlocker. Secures screws, nuts and bolts up to max. M36 against loosening due to vibration, and seals at the same time. Suitable for all metals, including passive materials such as stainless steel, aluminium and galvanised surfaces. Has proven tolerance to minor contamination from industrial oils, e.g. engine, corrosion protection and cutting oils. Bonds can be dismantled for maintenance using hand tools.

Functional strength: after 2 hours (22 °C)

Usage temperature range: -55 to +150 °C

Breakaway torque (M10 screws): 10 Nm

Bottle, 50 ml



281.270 Threadlocker, high-strength LOCTITE® 2701

Description:

Green, low-viscosity, vibration-resistant, methacrylate-based threadlocker for high-strength connections up to max. M20, especially for chrome-plated surfaces. Prevents unwanted movements, independent loosening, leakage and corrosion in the thread. Tolerates low oily contamination from industrial oils. Suitable for all threaded metal connections. Fluoresces under UV light. Secured parts cannot be dismantled easily.

Handling strength in 10 min. on steel, 4 min. on brass and 25 min. on stainless steel.

Usage temperature range: -55 to +150 °C

Breakaway torque (M10 screws): 38 Nm

Bottle, 50 ml



281.648 Retaining compound, high-strength LOCTITE® 648

Description:

For bonding cylindrical components, e.g. bearings, bushings, bolts and similar machine parts. Hardens under exclusion of air between tightly fitting metal surfaces and enables the transmission of higher forces and outputs with existing geometry and design solutions. For adhesion gap sizes up to 0.15 mm.

Preferably for the fitting of guide bushes from FIBRO.

Functional strength: after 5 min.

Usage temperature range: -55 to +175 °C

Bottle, 50 ml

EPOXY ADHESIVE LOCTITE® EA 3450

INSTANT ADHESIVE LOCTITE® 401

INSTANT ADHESIVE GEL LOCTITE® 454

281.147 Epoxy adhesive LOCTITE® EA 3450

Description:

Two-component epoxy adhesive that cures rapidly at ambient temperature after mixing. Develops high strength on metal surfaces. Due to its splitting capacity, it is suitable for rough and poorly fitting surfaces made of metals, ceramics, thermosets. For the high-strength repair of steel and cast parts, e.g. for repairing faulty machining on tool and machine parts (liquid metal).

Processing time: 4 to 6 min.

Handling strength: after 15 min.

Usage temperature range: -55 to +100 °C

Twin syringe, 25 ml



281.401 Instant adhesive LOCTITE® 401

Description:

Universal-use instant adhesive for bonding materials in applications where uniform stress distribution and high tensile and shearing strength are required. Achieves fast bonding with a variety of materials, e.g. metals, plastics and elastomers. Perfect for all quick repairs as well as small emergency repairs of all kinds.

Handling strength: after 3 - 10 sec.

Usage temperature range: -40 to +120 °C

Bottle, 50 g



281.454 Instant adhesive gel LOCTITE® 454

Description:

For joining materials that are difficult to bond and for applications where uniform stress distribution and high tensile and shearing strength are required. Achieves fast bonding with a variety of materials, including metals, plastics and elastomers. No dripping or draining - gel-like consistency ideal for vertical and overhead applications.

Handling strength: after 5 - 10 sec.

Usage temperature range: -40 to +120 °C

Tube, 20 g



